

JEFPO ONE DEPARTURE (RNAV)

D-ATIS
118.0
CLNC DEL
128.0
CPDLC
GND CON
121.7
SEATTLE TOWER
119.9 239.3 (Rwys 16L/34R, 16C/34C)
120.95 239.3 (Rwy 16R/34L)
SEATTLE DEP CON
120.4 269.125

**TOP ALTITUDE:
9000**



DEPARTURE ROUTE DESCRIPTION

TAKEOFF RUNWAY 34C: Climb heading 344° to 940, then direct NESOE, then on track 344° to cross WUREL at or above 3100, thence. . .

TAKEOFF RUNWAY 34L: Climb heading 344° to 940, then direct CUSBU, then on track 349° to cross WUREL at or above 3100, thence. . .

TAKEOFF RUNWAY 34R: Climb heading 344° to 940, then direct DODVE, then on track 342° to cross WUREL at or above 3100, thence. . .

. . . on track 309° to ATOME, then on track 281° to CENEX, then on track 343° to JEFPO, then on course 343°, expect RADAR vectors on course. Maintain 9000, expect clearance to filed altitude within 5 minutes after departure.

ALPSE

PAINÉ
PAE

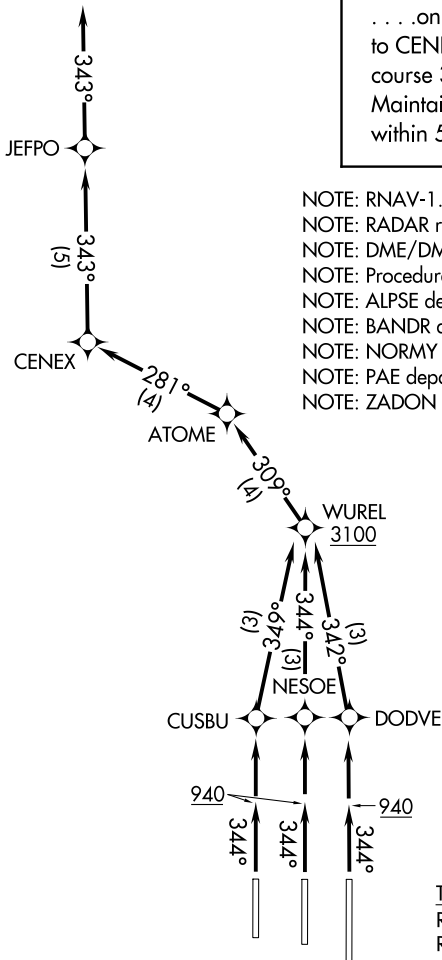

- NOTE: RNAV-1.
- NOTE: RADAR required.
- NOTE: DME/DME/IRU or GPS required.
- NOTE: Procedure available from 2200 to 0600 local.
- NOTE: ALPSE departures expect direct/vectors to ALPSE.
- NOTE: BANDR departures expect direct/vectors to BANDR.
- NOTE: NORMY departures expect direct/vectors to NORMY.
- NOTE: PAE departures expect direct/vectors to PAE VOR/DME.
- NOTE: ZADON departures expect direct/vectors to ZADON.

TAKEOFF MINIMUMS

Rwys 16L/C/R: NA, ATC.
Rwys 34L/C/R: Standard with minimum climb of 500' per NM to 940.

NOTE: Chart not to scale.

NW-1, 25 FEB 2021 to 25 MAR 2021

NW-1, 25 FEB 2021 to 25 MAR 2021